



BLACK BOX
NETWORK SERVICES

AVX-VGA-TP-TX
AVX-VGA-TP-TX-4
AVX-VGA-TP-TX-8

AVX-VGA-TP-SRX
AVX-VGA-TP-LRX
AVX-VGA-TP-CSRX

MediaCento™ VX Transmitters and Receivers

Economically extend and distribute VGA video, stereo audio, and serial signals over CATx.



Customer Support Information

Order toll-free in the U.S.: Call 877-877-BBOX (outside U.S. call 724-746-5500) • FREE technical support 24 hours a day, 7 days a week: Call 724-746-5500 or fax 724-746-0746 • Mailing address: Black Box Corporation, 1000 Park Drive, Lawrence, PA 15055-1018
Web site: www.blackbox.com • E-mail: info@blackbox.com

Trademarks Used in this Manual

Trademarks Used in this Manual

Black Box and the Double Diamond logo are registered trademarks, and MediaCento is a trademark, of BB Technologies, Inc.

Any other trademarks mentioned in this manual are acknowledged to be the property of the trademark owners.

FEDERAL COMMUNICATIONS COMMISSION AND INDUSTRY CANADA RADIO FREQUENCY INTERFERENCE STATEMENTS

This equipment generates, uses, and can radiate radio-frequency energy, and if not installed and used properly, that is, in strict accordance with the manufacturer's instructions, may cause interference to radio communication. It has been tested and found to comply with the limits for a Class A computing device in accordance with the specifications in Subpart B of Part 15 of FCC rules, which are designed to provide reasonable protection against such interference when the equipment is operated in a commercial environment. Operation of this equipment in a residential area is likely to cause interference, in which case the user at his own expense will be required to take whatever measures may be necessary to correct the interference.

Changes or modifications not expressly approved by the party responsible for compliance could void the user's authority to operate the equipment.

This digital apparatus does not exceed the Class A limits for radio noise emission from digital apparatus set out in the Radio Interference Regulation of Industry Canada.

Le présent appareil numérique n'émet pas de bruits radioélectriques dépassant les limites applicables aux appareils numériques de classe A prescrites dans le Règlement sur le brouillage radioélectrique publié par Industrie Canada.

Normas Oficiales Mexicanas (NOM) Electrical Safety Statement INSTRUCCIONES DE SEGURIDAD

1. Todas las instrucciones de seguridad y operación deberán ser leídas antes de que el aparato eléctrico sea operado.
2. Las instrucciones de seguridad y operación deberán ser guardadas para referencia futura.
3. Todas las advertencias en el aparato eléctrico y en sus instrucciones de operación deben ser respetadas.

NOM Statement

4. Todas las instrucciones de operación y uso deben ser seguidas.
5. El aparato eléctrico no deberá ser usado cerca del agua—por ejemplo, cerca de la tina de baño, lavabo, sótano mojado o cerca de una alberca, etc.
6. El aparato eléctrico debe ser usado únicamente con carritos o pedestales que sean recomendados por el fabricante.
7. El aparato eléctrico debe ser montado a la pared o al techo sólo como sea recomendado por el fabricante.
8. Servicio—El usuario no debe intentar dar servicio al equipo eléctrico más allá a lo descrito en las instrucciones de operación. Todo otro servicio deberá ser referido a personal de servicio calificado.
9. El aparato eléctrico debe ser situado de tal manera que su posición no interfiera su uso. La colocación del aparato eléctrico sobre una cama, sofá, alfombra o superficie similar puede bloquea la ventilación, no se debe colocar en libreros o gabinetes que impidan el flujo de aire por los orificios de ventilación.
10. El equipo eléctrico deber ser situado fuera del alcance de fuentes de calor como radiadores, registros de calor, estufas u otros aparatos (incluyendo amplificadores) que producen calor.
11. El aparato eléctrico deberá ser conectado a una fuente de poder sólo del tipo descrito en el instructivo de operación, o como se indique en el aparato.
12. Precaución debe ser tomada de tal manera que la tierra física y la polarización del equipo no sea eliminada.
13. Los cables de la fuente de poder deben ser guiados de tal manera que no sean pisados ni pellizcados por objetos colocados sobre o contra ellos, poniendo particular atención a los contactos y receptáculos donde salen del aparato.
14. El equipo eléctrico debe ser limpiado únicamente de acuerdo a las recomendaciones del fabricante.
15. En caso de existir, una antena externa deberá ser localizada lejos de las líneas de energía.

16. El cable de corriente deberá ser desconectado del cuando el equipo no sea usado por un largo periodo de tiempo.
17. Cuidado debe ser tomado de tal manera que objetos líquidos no sean derramados sobre la cubierta u orificios de ventilación.
18. Servicio por personal calificado deberá ser provisto cuando:
 - A: El cable de poder o el contacto ha sido dañado; u
 - B: Objetos han caído o líquido ha sido derramado dentro del aparato; o
 - C: El aparato ha sido expuesto a la lluvia; o
 - D: El aparato parece no operar normalmente o muestra un cambio en su desempeño; o
 - E: El aparato ha sido tirado o su cubierta ha sido dañada.

Table of Contents

Table of Contents

1. Specifications.....	8
2. Overview	10
2.1 Introduction	10
2.2 Features.....	10
2.3 What's Included.....	11
2.4 Hardware Description.....	13
2.4.1 1-Port Transmitter (AVX-VGA-TP-TX).....	13
2.4.2 4-Port Transmitter (AVX-VGA-TP-TX-4).....	15
2.4.3 8-Port Transmitter (AVX-VGA-TP-TX-8).....	17
2.4.4 Standard Receiver (AVX-VGA-TP-SRX) and Long-Range Receiver (AVX-VGA-TP-LRX).....	19
2.4.5 Cascadable Long-Range Receiver (AVX-VGA-TP-CSRX).....	21
2.4.6 Slide Switches (AVX-VGA-TP-TX-4, AVX-VGA-TP-TX-8, AVX-VGA-TP-CSRX).....	23
3. Installation	25
3.1 1-Port Transmitter + Receiver.....	25
3.2 1-Port Transmitter + Cascadable Receiver + Receiver (Non-Cascaded Application).....	26
3.3 1-Port Transmitter + Cascadable Receiver + Receiver (Cascaded Application).....	27
3.4 4-/8-Port Transmitter + Cascadable Receiver + Receiver (Non-Cascaded Application).....	28
3.5 4-/8-Port Transmitter + Cascadable Receiver + Receiver (Cascaded Application).....	29
4. Operation	30
4.1 Video Adjustment on the Receiver/Casadable Receiver Unit.....	30
4.2 EDID Setting on Transmitter.....	31
4.2.1 EDID Copy.....	31
4.2.2 Use (Load) Default Setting.....	31
4.3 Factory Default Setting on Transmitters and Receivers.....	32
4.3.1 Factory Default Setting on the Transmitter.....	32
4.3.2 Factory Default Setting on the Receiver.....	32
5. LED Indicators.....	33

Table of Contents

6. Serial Interface.....	36
Appendix. CAT5 Cables	37

Chapter 1: Specifications

1. Specifications

Distance (Maximum) —

AVX-VGA-TP-TX, AVX-VGA-TP-TX-4, AVX-VGA-TP-TX-8:

When used with AVX-VGA-TP-SRX receiver: 328 ft. (100 m);

When used with AVX-VGA-TP-LRX or AVX-VGA-TP-CSRX receiver:
1000 ft.(300 m);

When used with AVX-VGA-TP-LRX and AVX-VGA-TP-CSRX receivers:
1475 ft. (450 m);

AVX-VGA-TP-SRX: 328 ft. (100 m);

AVX-VGA-TP-LRX: 1000 ft. (300 m)

NOTE: 1475 feet has been tested and recommended as the maximum distance, however, with a good quality cable and environment, distances beyond 2000 feet can be achieved.

MTBF — 90,000 hours

Resolution (Maximum) — 1920 x 1200 at maximum distance

User Controls — AVX-VGA-TP-TX: (1) EDID copy button;

AVX-VGA-TP-TX-4, AVX-VGA-TP-TX-8: (1) EDID copy button; (1) master/slave switch; (1) cascade on/off switch;

AVX-VGA-TP-SRX, AVX-VGA-TP-LRX, AVX-VGA-TP-CSRX: (3) push buttons: (1) for entering/exiting video adjustment mode; (1) to increase video adjustment one level; (1) to decrease video adjustment one level

Approvals — CE, RoHS

Connectors —

AVX-VGA-TP-TX, AVX-VGA-TP-TX-4, AVX-VGA-TP-TX-8:

Video input: (1) HD15 F (VGA);

Audio input: (1) 3.5-mm jack (stereo);

Serial input: (1) DB9 F (RS-232 TX/GND signals);

Local audio input: (1) 3.5-mm jack (stereo);

System configuration: (1) RJ-11 (connects to a host's serial port via included control cable and RJ-11/DB9 converter);

Power: (1) 2.1-mm barrel jack;

Ground: (1) ground connector;

AVX-VGA-TP-TX also has: Local video output: (1) HD15 F (VGA);

Interconnect: (1) RJ-45;

Connectors (Continued)—

AVX-VGA-TP-TX-4 also has:

Cascade output: (1) HD15 F (VGA) for video and RS-232;

Interconnect: (4) RJ-45;

AVX-VGA-TP-TX-8 also has:

Cascade output: (1) HD15 F (VGA) for video and RS-232;

Interconnect: (8) RJ-45;

AVX-VGA-TP-SRX, AVX-VGA-TP-LRX, AVX-VGA-TP-CSRX:

Audio output: (1) 3.5-mm jack (stereo);

Interconnect: (1) RJ-45;

Serial output: (1) DB9 M (RS-232 TX/GND signals);

Power: (1) 2.1-mm barrel jack;

Ground: (1) ground connector;

AVX-VGA-TP-SRX, AVX-VGA-TP-LRX also have:

Video output: (1) HD15 F (VGA);

AVX-VGA-TP-CSRX also has:

Video output/cascade: (1) HD15 F (VGA) for video and RS-232;

Repeater/daisychain: (1) RJ-45 (CATx out)

Indicators — (2) LEDs: (1) Power/Source Input, (1) Link

Power — External, in-line adapter:

Input: 100–240 VAC, 50–60 Hz, 0.6 amps (maximum);

Output: 12 VDC, 1.5 amps (maximum);

Consumption: 18 watts

Size — AVX-VGA-TP-TX: 1.6"H x 5"W x 4"D (4.1 x 12.7 x 10.2 cm);

AVX-VGA-TP-TX-4, AVX-VGA-TP-TX-8: 1.6"H x 6.75"W x 4"D

(4.1 x 17.1 x 10.2 cm);

AVX-VGA-TP-SRX, AVX-VGA-TP-LRX, VX-VGA-TP-CSRX:

0.9"H x 4.25"W x 3.4"D (2.3 x 10.8 x 8.6 cm)

Weight — AVX-VGA-TP-TX: 1 lb. (0.45 kg);

AVX-VGA-TP-TX-4, AVX-VGA-TP-TX-8: 1.6 lb. (0.7 kg);

AVX-VGA-TP-SRX, AVX-VGA-TP-LRX, AVX-VGA-TP-CSRX: 0.7 lb. (0.3 kg)

Chapter 2: Overview

2. Overview

2.1 Introduction

The MediaCento VX Extender pair (Tx + Rx) transmits VGA + Audio + Serial signals via CATx cable(s). With one Cascadable Receiver and one Long-Range Receiver, it extends up to and over 450 meters away with WUXGA (1920 x 1200)/Full HD (1920 x 1080) resolution. Via cascading, up to 32 threads and more than 1000 display units broadcast audio/video signals simultaneously to expand system capability. Each audio or video port can be independently turned on/off. To ensure video quality, users may manually adjust video signal on Gain (Brightness), Equalizer (Sharpness), and RGB skew on all receivers (and cascadable receiver).

However, in some cases display problems may occur because of incorrect EDID communication between the display monitor and the unit or inappropriate EDID data programmed by display manufacturers. The EDID Copy function enables the system to either read the necessary EDID information from the unit or copy EDID from EDID-compliant displays.

The Graphical User Interface (GUI) is easy to use. You can not only enable or disable audio/video output simply by clicking the icons, but you can also sort the units by grouping, which makes management easy. Using the GUI does not use complex commands. You can portray or rename display icons. The system is ideal for public broadcasting, exhibits, retail stores, courtrooms, stock tickers, bus stations, etc.

2.2 Features

- Transmit VGA + Audio + Serial signals via CATx technology up to and beyond 1440 feet (450 meters) away with repeaters in between.
- Cascade units to broadcast up to 32 threads to more than 1000 display units; expand system capability.
- Unique Equalizer (sharpness)/Gain (brightness)/RGB Skew adjustment via push buttons provides optimal video quality.
- Independently turn ON/OFF the audio and video of the remote ports.
- Automatically detects and indicates the source video signal.
- EDID Copy function.
- Supports surge protection.
- Audible confirmation beeps make operation and cross-checking easier.
- LED indicators monitor status.

- Support group monitoring: sort your screens by group and manage them easily.
- Compatible with most popular screen resolutions, including WUXGA (1920 x 1200)/Full HD (1920 x 1080)/UXGA (1600 X 1200).
- Ideal for public broadcasting, exhibits, retail stores, courtrooms, stock tickers, bus stations, etc.

Exclusive GUI Features

- Graphically describes connection status.
- Duplicates most commonly used menu items as icons on the top.
- User-defined icon available: Name and use your own images for every source and display icon.
- GUI function makes control easier and more effective.

2.3 What's Included

Your package should include the following items. If anything is missing or damaged, contact Black Box Technical Support at 724-746-5500 or info@blackbox.com.

AVX-VGA-TP-TX:

- (1) 1-Port Transmitter
- (1) power supply and U.S. power cord
- (1) 3.5-mm audio cable
- (1) control cable RJ-11/DB9 F
- (1) ground cable
- (1) set of four rubber feet
- This user manual

AVX-VGA-TP-TX-4:

- (1) 4-Port Transmitter
- (1) power supply and U.S. power cord
- (1) 3.5-mm audio cable
- (1) control cable RJ-11/DB9 F
- (1) ground cable
- (1) set of four rubber feet
- This user manual

Chapter 2: Overview

AVX-VGA-TP-TX-8:

- (1) 8-Port Transmitter
- (1) power supply and U.S. power cord
- (1) 3.5-mm audio cable
- (1) control cable RJ-11/DB9 F
- (1) ground cable
- (1) set of four rubber feet
- This user manual

AVX-VGA-TP-SRX:

- (1) Standard Receiver, 100 m
- (1) power supply and U.S. power cord
- (1) 3.5-mm audio cable
- (1) ground cable
- (1) set of four rubber feet
- This user manual

AVX-VGA-TP-LRX:

- (1) Long-Range Receiver, 300 m
- (1) power supply and U.S. power cord
- (1) ground cable
- (1) set of four rubber feet
- This user manual

AVX-VGA-TP-CSRX:

- (1) Long-Range Cascadable Receiver, 300 m
- (1) power supply and U.S. power cord
- (1) ground cable
- (1) set of four rubber feet
- This user manual

2.4 Hardware Description

Figures 2-1 through 2-5 show the front and back panels of the extenders. Table 2-1 through 2-5 describe their components.

2.4.1 1-Port Transmitter (AVX-VGA-TP-TX)

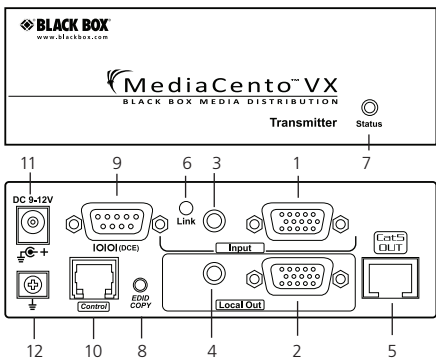

Figure 2-1. AVX-VGA-TP-TX front and back panels.

Chapter 2: Overview

Table 2-1. AVX-VGA-TP-TX components.

Number	Component	Description
1	HD15 connector	Connect to a VGA source.
2	HD15 connector	Connect to a VGA monitor.
3	Audio jack	Connect to an audio source.
4	Audio jack	Connect to a speaker.
5	RJ-45 jack	Connect to a repeater/receiver.
6	Link LED	Green: Directly connect to an active receiver. Off: No active receiver directly connected.
7	Status LED	Green: Power on (without source input). Blue: Source input.
8	Push button	EDID setting (see EDID Setting, Section 4.2).
9	Serial port	Connect to a serial port for serial extension.
10	RJ-11 jack	Connect to a host's serial port for system configuration.
11	Barrel connector	Links to power supply.
12	Ground terminal	Connect to common ground.

2.4.2 4-Port Transmitter (AVX-VGA-TP-TX-4)

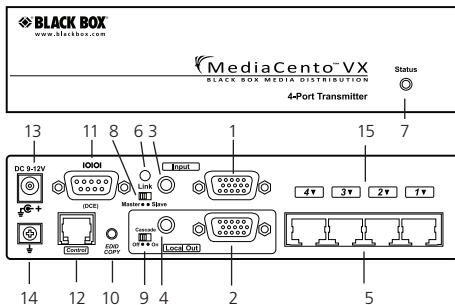

Figure 2-2. AVX-VGA-TP-TX-4 front and back panels.

Chapter 2: Overview

Table 2-2. AVX-VGA-TP-TX-4 components.

Number	Component	Description
1	HD15 connector	Connect to a VGA source.
2	HD15 connector	Connect to a VGA monitor.
3	Audio jack	Connect to an audio source.
4	Audio jack	Connect to a speaker.
5	(4) RJ-45 jacks	Connect to a repeater/receiver.
6	Link LED	Off: Master mode. Red: Slave mode without source input. Green: Slave mode with source input.
7	Status LED	Green: Power on (without source input). Blue: Source input.
8	Master/Slave slide switch	See Section 2.4.6, Slide Switch.
9	Cascade slide switch	See Section 2.4.6, Slide Switch.
10	Push button	EDID setting (see EDID Setting, Section 4.2).
11	Serial port	Connect to a serial port for serial extension.
12	RJ-11 jack	Connect to a host's serial port for system configuration.
13	Barrel connector	Connect power supply.
14	Ground terminal	Connect to common ground.

2.4.3 8-Port Transmitter (AVX-VGA-TP-TX-8)

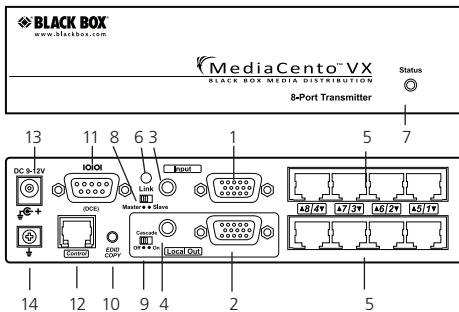

Figure 2-3. AVX-VGA-TP-TX-8 front and back panels.

Chapter 2: Overview

Table 2-3. AVX-VGA-TP-TX-8 components.

Number	Component	Description
1	HD15 connector	Connect to a VGA source.
2	HD15 connector	Connect to a VGA monitor.
3	Audio jack	Connect to an audio source.
4	Audio jack	Connect to a speaker.
5	(8) RJ-45 jacks	Connect to a repeater/receiver.
6	Link LED	Off: Master mode. Red: Slave mode without source input. Green: Slave mode with source input.
7	Status LED	Green: Power on (without source input). Blue: Source input.
8	Master/Slave slide switch	See Section 2.4.6, Slide Switches.
9	Cascade slide switch	See Section 2.4.6, Slide Switches.
10	Push button	EDID setting (see EDID Setting, Section 4.2).
11	DB9 serial port	Connect to a serial port for serial extension.
12	RJ-11 jack	Connect to a host's serial port for system configuration.
13	Barrel connector	Links to power supply.
14	Ground terminal	Connect to common ground.

2.4.4 Standard Receiver (AVX-VGA-TP-SRX) and Long-Range Receiver (AVX-VGA-TP-LRX)

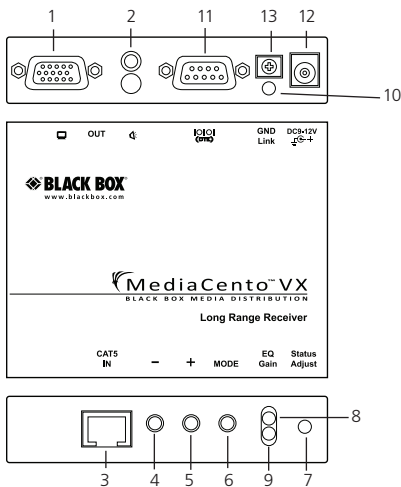

Figure 2-4. AVX-VGA-TP-SRX or AVX-VGA-TP-LRX front, top, and back panels.

Chapter 2: Overview

Table 2-4. AVX-VGA-TP-SRX or AVX-VGA-TP-LRX components.

Number	Component	Description
1	HD15 connector	Connect to a VGA monitor.
2	Audio jack	Connect to a speaker.
3	RJ-45 jack	Connect to a transmitter/repeater.
4	Push button: - Minus	Press once to decrease one level.
5	Push button: + Plus	Press once to increase one level.
6	Push button: Mode	Press the button for two seconds to enter/exit video adjustment mode.
7	Status LED	Normal: Green: Power on Blue: Power + Video OK Video adjustment: Flashing Red/Green/Blue: Adjusting skew (red/green/blue).
8	EQ LED	Flashing Yellow: Adjust EQ.
9	Gain LED	Flashing Yellow: Adjust Gain (brightness).
10	Link LED	Red: No transmitter/broadcaster connected. Green: Connect to a transmitter.
11	DB9 serial port	Connect to a serial device for serial extension.

Table 2-4 (Continued). AVX-VGA-TP-SRX or AVX-VGA-TP-LRX components.

Number	Component	Description
12	Barrel conector	Links to power supply.
13	Ground terminal	Connect to common ground.

2.4.5 Cascadable Long-Range Receiver (AVX-VGA-TP-CSRX)

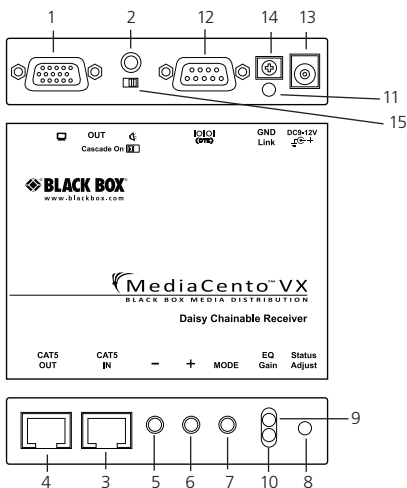

Figure 2-5. AVX-VGA-TP-CSRX front and back panels.

Chapter 2: Overview

Table 2-5. AVX-VGA-TP-CSRX components.

Number	Component	Description
1	HD15 connector	Cascade off: Connect to a VGA monitor. Cascade on: Connect to a transmitter's T1 port.
2	Audio jack	Connect to a speaker.
3	RJ-45 jack	Connect to a transmitter/repeater.
4	RJ-45 jack	Connect to a receiver/cascadable receiver.
5	Push button: - Minus	Press once to decrease one level.
6	Push button: + Plus	Press once to increase one level.
7	Push button: Mode	Press the button for two seconds to enter/exit video adjustment mode.
8	Status LED	Normal: Green: Power on Blue: Power + Video OK Video adjustment: Flashing Red/Green/Blue: Adjusting skew (red/green/blue).
9	EQ LED	Flashing Yellow: Adjust EQ.
10	Gain LED	Flashing Yellow: Adjust Gain (brightness).
11	Link LED	Red: No transmitter/broadcaster connected. Green: Connect to a transmitter.

Table 2-5 (Continued). AVX-VGA-TP-CSRX components.

Number	Component	Description
12	Serial port	Connect to a serial device for serial extension.
13	Barrel connector	Links to power supply.
14	Ground terminal	Connect to common ground.
15	Slide switch	Cascade ON/OFF

2.4.6 Slide Switches (AVX-VGA-TP-TX-4, AVX-VGA-TP-TX-8, AVX-VGA-TP-CSRX)



Figure 2-6. Slide switches.

Chapter 2: Overview

NOTE: The Master/Slave slide switch is on 4- and 8-port transmitters (AVX-VGA-TP-TX-4, AVX-VGA-TP-TX-8) only. The Cascade slide switch is on 4- and 8-port transmitters (AVX-VGA-TP-TX-4, AVX-VGA-TP-TX-8) and the cascable receiver (AVX-VGA-TP-CRX).

Table 2-6. Slide switches on the 4-/8-Port Transmitter.

Switch	Description
Master/Slave slide switch	Master: Unit is set as a source provider. Slave: When this unit is a source duplicator, it accepts an RS-232 signal from HD15.
Cascade slide switch	Off: The video connector on a transmitter connects to a VGA monitor. On: When the video connector on a transmitter connects to a downstream transmitter, it sends RS-232 through HD15 connection.

Table 2-7. Slide switch on the Cascadable Receiver (AVX-VGA-TP-CRX).

Switch	Description
Cascade slide switch	Off: The video connector on a receiver connects to a VGA monitor. On: When the video connector on a receiver connects to a downstream transmitter, it sends RS-232 through HD15 connection.

3. Installation

WARNING:

- Before installation, power off all devices that will be connected to this system.
- Make sure that all devices you will connect are properly grounded.
- Place cables away from fluorescent lights, air conditioners, and machines that are likely to generate electrical noise.

Grounding

To prevent any damage to the product or any connecting devices, make sure that the extender systems are properly grounded.

Connection Pattern

The following figures show typical applications of the MediaCento VX transmitters and receivers.

3.1 1-Port Transmitter + Receiver

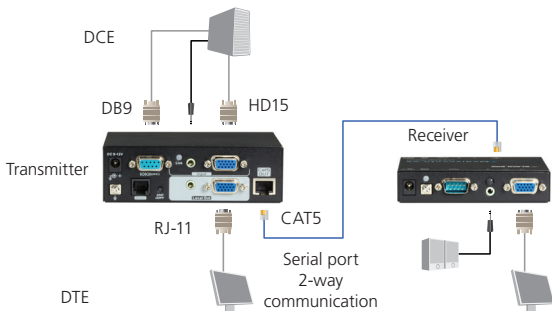

Figure 3-1. Connection pattern for 1-Port Transmitter + Receiver.

Chapter 3: Installation

3.2 1-Port Transmitter + Cascadable Receiver + Receiver (Non-Cascaded Application)

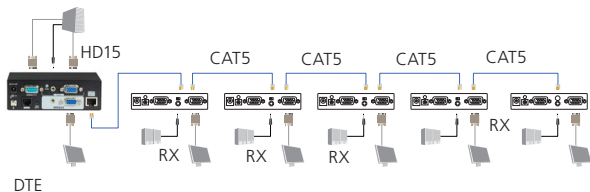

Figure 3-2. Connection pattern for 1-Port Transmitter + Cascadable Receiver + Receiver (Non-Cascaded Application).

3.3 1-Port Transmitter + Cascadable Receiver + Receiver (Cascaded Application)

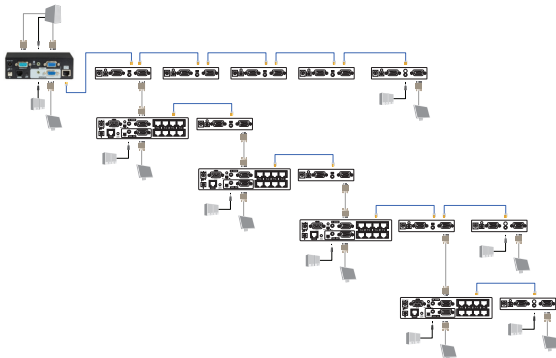

Figure 3-3. Connection pattern for 1-Port Transmitter + Cascadable Receiver + Receiver (Cascaded Application).

Chapter 3: Installation

3.4 4-/8-Port Transmitter + Cascadable Receiver + Receiver (Non-Cascaded Application)

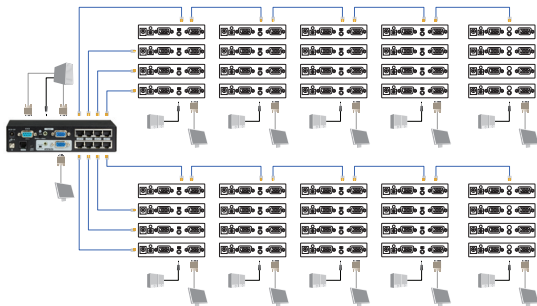

Figure 3-4. Connection pattern for 4-/8-Port Transmitter + Cascadable Receiver + Receiver (Non-Cascaded Application).

3.5 4-/8-Port Transmitter + Cascadable Receiver + Receiver (Cascaded Application)

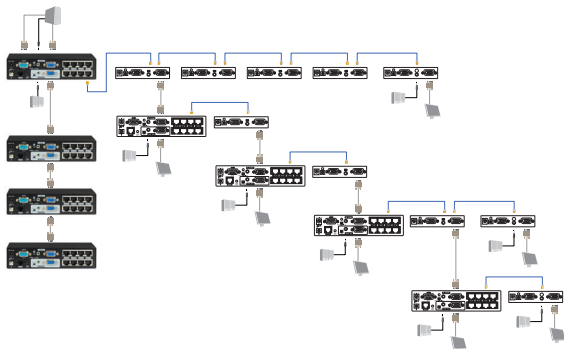

Figure 3-5. Connection pattern for 4-/8-Port Transmitter + Cascadable Receiver + Receiver (Cascaded Application).

4. Operation

4.1 Video Adjustment on Receiver/Cascadable Receiver Unit

To optimize the video signal associated with various cable lengths, users may adjust the video compensation on the Receiver / Repeater Unit. It follows the order in sequence of: EQ—>Gain—>Skew (Red—>Green—>Blue)—>EQ—>Gain...

STEP 1: Press and hold the “Mode” button for two seconds. When the “EQ” LED flashes yellow with one beep, the receiver enters video adjustment mode.

STEP 2: Press the “+” or “-” button once (you will hear a clicking sound) to increase or decrease one level of video adjustment. You will hear a long buzzer when the receiver reaches its limit.

STEP 3: Press the “Mode” button to go to the next phase (Gain). The “Gain” LED flashes yellow with one beep sound. Follow STEP 2 above for adjustment.

STEP 4: Press the “Mode” button to go to the next phase (Skew). The “Skew” LED flashes red/green/blue with one beep sound. Follow STEP 2 above for adjustment. The “Skew” LED flashes red, green, or blue to indicate which color is being adjusted. You will hear a long buzzer sound when the receiver reaches its limit.

STEP 5: Press and hold the “Mode” button for two seconds. You will hear one beep when the receiver exits Video Adjustment mode.

NOTE: The timeout is set around 20 seconds.

Table 4-1. LED indicators in Video Adjustment Mode.

LED	Status
EQ	Flashing Yellow: Adjust EQ
Gain	Flashing Yellow: Adjust Gain (brightness)
Status (Skew)	Flashing Red: Adjust Skew (Red) Flashing Green: Adjust Skew (Green) Flashing Blue: Adjust Skew (Blue)

4.2 EDID Setting on a Transmitter

In some cases, display problems may occur because of incorrect EDID communication between the display monitor and the unit or inappropriate EDID data programmed by display manufacturers. The EDID Copy function enables the system to either read the necessary EDID information from the unit or copy EDID from EDID-compliant displays.

NOTE: Before starting EDID Setting, ensure the Cascade Switch is in the "OFF" position.

4.2.1 EDID Copy

If the transmitter EDID does not match the EDID of the attached displays, copy the EDID from the displays.

STEP 1: Apply power to the unit.

STEP 2: Connect the display to the Video Out connector on the transmitter and power on the display.

STEP 3: Press the "EDID Copy" button and release the button RIGHT AFTER the LED flashes green.

STEP 4: The LED flashes red and green alternately and returns to normal status indicating that the copy is successful.

Otherwise, if the LED flashes RED:

- The monitor is not properly connected.
- The monitor is not powered on.
- EDID data of the monitor is not applicable.

Repeat STEPS 2 and 3.

4.2.2 Use (Load) Default Setting

When using a monitor that is NOT EDID compliant, the transmitter will automatically select viable EDID data from the transmitter's EDID profile to set up the EDID information.

STEP 1: Apply power to the transmitter.

STEP 2: Press the "EDID Copy" button and release the button RIGHT AFTER the LED flashes red.

STEP 3: The LED flashes red and green alternately and returns to normal status when the copy is successful.

Chapter 4: Operation

4.3 Factory Default Settings on Transmitters and Receivers

To restore the transmitters and receivers to the default settings, follow these steps.

4.3.1 Factory Default Setting on the Transmitter

STEP 1: Press and hold the “EDID Copy” button.

STEP 2: Apply power to the transmitter.

STEP 3: Release the button RIGHT AFTER you hear the two-beep sound.

NOTE: A one-beep sound is used to confirm power supply.

STEP 4: Power cycle the unit.

4.3.2 Factory Default Setting on the Receiver

STEP 1: Press and hold the “+” button.

STEP 2: Apply power to the receiver.

STEP 3: Release the button RIGHT AFTER you hear the two-beep sound.

NOTE: A one-beep sound is used to confirm power supply.

STEP 4: Power cycle the unit.

5. LED Indicators

Table 5-1. 1-Port Transmitter LEDs.

LED	Status	Description
Link	Green	Lights when the transmitter is connected to an active receiver
	Green	Power on (no video source input)
Status	Blue	Power on and video source detected (source input detected); LED turns green six seconds after unplugging the source

Table 5-2. 4-/8-Port Transmitter LEDs.

LED	Status	Description
Link	Off	Switch: Master
	Red	Switch: Slave (no source input)
	Green	Switch: Slave (source detected)

NOTE: Table 5-2 is continued on the next page.

Chapter 5: LED Indicators

Table 5-2 (Continued). 4-/8-Port Transmitter LEDs.

LED	Status	Description
	Green	Power on (no video source input)
	Blue	Power on and video source detected (source input detected); LED turns green six seconds after unplugging the source)
Status	Emits blue with green flashing once	Source detected (local audio output is off)
	Emits blue with green flashing twice	Source detected (local video output is off)
	Emits blue with green flashing three times	Source detected (local audio and video output are off)
	Emits green with green flashing once	No source input (local audio output is off)
	Emits green with green flashing twice	No source input (local video output is off)
	Emits green with green flashing three times	No source input (local audio and video outputs are off)

Chapter 5: LED Indicators

Table 5-3. Receiver LEDs.

LED	Status	Status
Link	Red	Power on
	Green	CAT5 connection detected
Status	Green	Power on (no video source input)
	Blue	Power on and video source detected (source input detected); LED turns green six seconds after unplugging the source)
	Emits blue with green flashing once	Source detected (local audio output is off)
	Emits blue with green flashing twice	Source detected (local video output is off)
	Emits blue with green flashing three times	Source detected (local audio and video output are off)
	Emits green with green flashing once	No source input (local audio output is off)
	Emits green with green flashing twice	No source input (local video output is off)
	Emits green with green flashing three times	No source input (local audio and video outputs are off)
EQ	Flashing yellow	RS-232 off
	Off	RS-232 on

Chapter 6: Serial Interface

6. Serial Interface

NOTE: The MediaCentro VX management software can be found on the Black Box Web site (www.blackbox.com). Navigate to one of the product pages by entering "MediaCentro VX" into the search text box. You will find the software user manual and software download link under "Resources" in each product of the family. For further questions, contact Black Box Technical Support at 724-746-5500 or info@blackbox.com

Appendix. CAT5 Cables

The extender pair requires a piece of unshielded twisted-pair (UTP) CAT5 cable. The cable should be wired according to the TIA/EIA 568B standard shown below.

Table A-1.

Pin	Wire Color	Pair
1	White/Orange	2
2	Orange	2
3	White/Green	3
4	Blue	1
5	White/Blue	1
6	Green	3
7	White/Brown	4
8	Brown	4

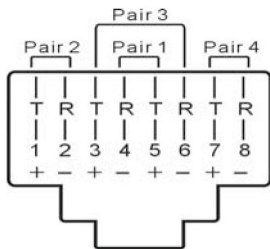

NOTE: Use CAT5, CAT5e, or CAT6 cables to connect the extender pair.

The diagram above shows the RJ-45 connector of a CAT5 cable with its metal contacts facing up.

Black Box Tech Support: FREE! Live. 24/7.

Tech support the
way it should be.



Great tech support is just 30 seconds away
at 724-746-5500 or blackbox.com.



About Black Box

Black Box provides an extensive range of networking and infrastructure products. You'll find everything from cabinets and racks and power and surge protection products to media converters and Ethernet switches all supported by free, live 24/7 Tech support available in 30 seconds or less.

© Copyright 2013. Black Box Corporation. All rights reserved.

AVX-VGA-TP-TX, version 1

724-746-5500 | blackbox.com